

UTR[®]

Air Gomm GmbH

Abstreifer

метелосборник

raschitto

racleur



Air Gomm GmbH, Bahnhofstrasse 5, CH-5316 Felsenau / AG,
+41 56 246 12 13,
info@air-gomm.ch

Hauptabstreifer secondary scraper

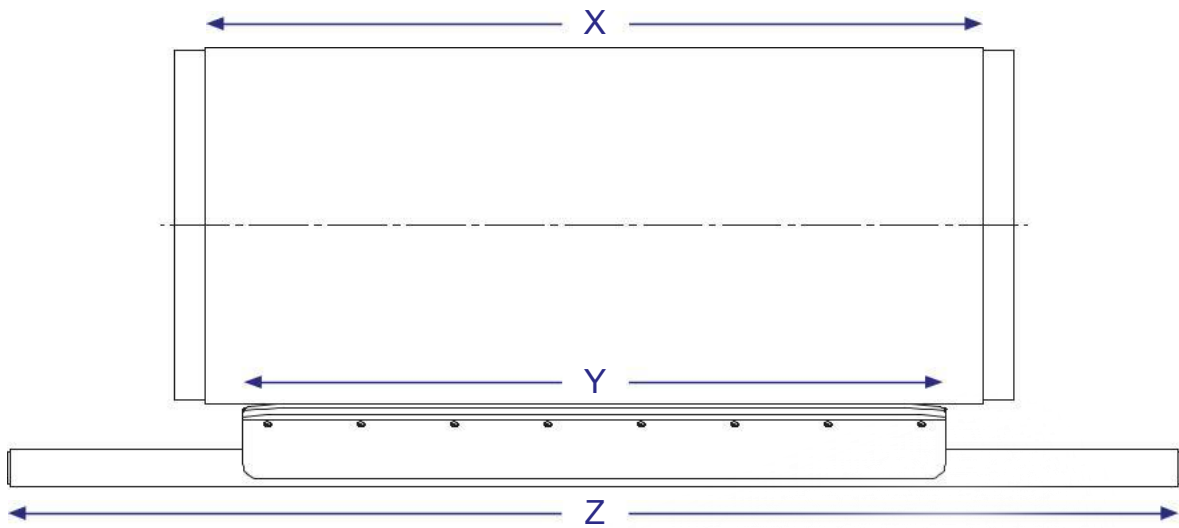

Vorabstreifer primary scraper

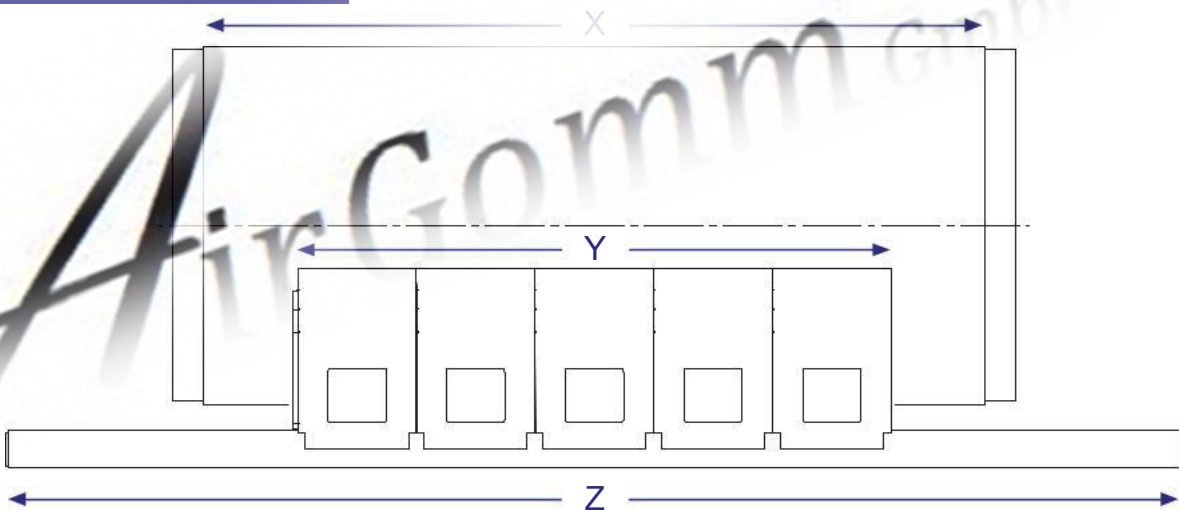

Innengurtabstreifer inline scraper

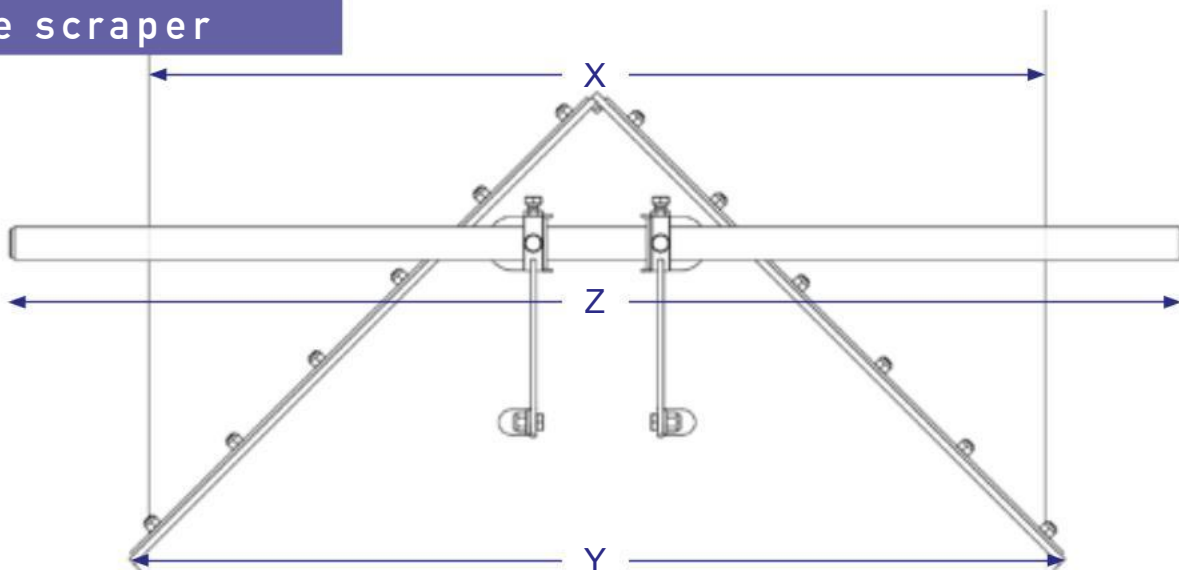

UTR Prime 45°

Air Gomm GmbH

Vmax: 3.0 m/sec.



-20°C/+200°C

Vmax: 3.5 m/sec.

-20°C/+70°C

BB: 400mm-3000mm



x	y	z			
			A	B	C
400	350	1000	001-001-350/45°	001-002-350/45°	001-003-400/48
500	450	1000	001-001-450/45°	001-002-450/45°	001-003-500/48
650	550	1200	001-001-550/45°	001-002-550/45°	001-003-650/48
650	600	1200	001-001-600/45°	001-002-600/45°	001-003-650/48
800	700	1300	001-001-700/45°	001-002-700/45°	001-003-800/48
800	750	1300	001-001-750/45°	001-002-750/45°	001-003-800/48
1000	900	1500	001-001-900/45°	001-002-900/45°	001-003-1000/48
1000	950	1500	001-001-950/45°	001-002-950/45°	001-003-1000/48
1200	1050	1700	001-001-1050/45°	001-002-1050/45°	001-003-1200/60
1200	1125	1700	001-001-1125/45°	001-002-1125/45°	001-003-1200/60
1400	1200	1900	001-001-1200/45°	001-002-1200/45°	001-003-1400/60
1400	1300	1900	001-001-1300/45°	001-002-1300/45°	001-003-1400/60
1600	1400	2100	001-001-1400/45°	001-002-1400/45°	001-003-1600/60
1600	1500	2100	001-001-1500/45°	001-002-1500/45°	001-003-1600/60
1800	1600	2300	001-001-1600/45°	001-002-1600/45°	001-003-1800/60
1800	1700	2300	001-001-1700/45°	001-002-1700/45°	001-003-1800/60
2000	1800	2500	001-001-1800/45°	001-002-1800/45°	001-003-2000/70
2000	1900	2500	001-001-1900/45°	001-002-1900/45°	001-003-2000/70



D	E	F	G	H	I	J
						
050-001-400-650	050-005-400-650	050-003-400-650	050-004-400-650	050-009-M24	050-010-M24	050-011-M24
050-001-800-1000	050-005-800-1000	050-003-800-1000	050-004-800-1000	050-009-M30	050-010-M30	050-011-M30
050-001-1200-1800	050-005-1200-1800	050-003-1200-1800	050-004-1200-1800	050-009-M36	050-010-M36	050-011-M36
050-001-2000-2400	050-005-2000-2400	050-003-2000-2400	050-004-2000-2400	050-009-M42	050-010-M42	050-011-M42

UTR Prime 90°

Air Gomm GmbH

Vmax: 3.0 m/sec



-100°C/+200°C

Vmax: 3.5 m/sec



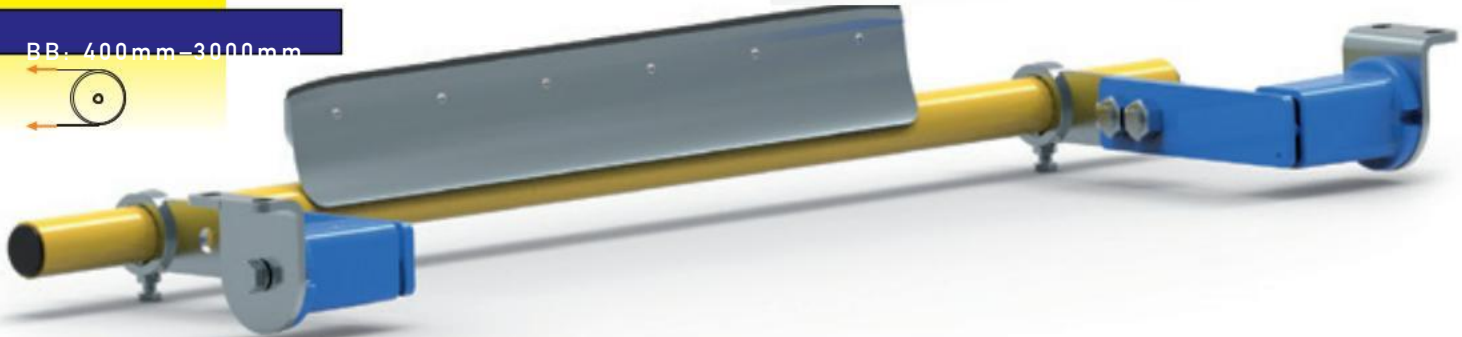
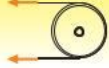

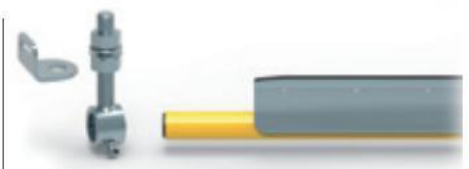

-20°C/+70°C

BB: 400mm-3000mm



							
	x	y	z	A	B	C	
Ø48	400	350	1000	001-001-350/90°	001-002-350/90°	001-003-400/48	
	500	450	1000	001-001-450/90°	001-002-450/90°	001-003-500/48	
	650	550	1200	001-001-550/90°	001-002-550/90°	001-003-650/48	
	650	600	1200	001-001-600/90°	001-002-600/90°	001-003-650/48	
	800	700	1300	001-001-700/90°	001-002-700/90°	001-003-800/48	
	800	750	1300	001-001-750/90°	001-002-750/90°	001-003-800/48	
	1000	900	1500	001-001-900/90°	001-002-900/90°	001-003-1000/48	
	1000	950	1500	001-001-950/90°	001-002-950/90°	001-003-1000/48	
	Ø60	1200	1050	1700	001-001-1050/90°	001-002-1050/90°	001-003-1200/60
		1200	1125	1700	001-001-1125/90°	001-002-1125/90°	001-003-1200/60
1400		1200	1900	001-001-1200/90°	001-002-1200/90°	001-003-1400/60	
1400		1300	1900	001-001-1300/90°	001-002-1300/90°	001-003-1400/60	
1600		1400	2100	001-001-1400/90°	001-002-1400/90°	001-003-1600/60	
1600		1500	2100	001-001-1500/90°	001-002-1500/90°	001-003-1600/60	
1800		1600	2300	001-001-1600/90°	001-002-1600/90°	001-003-1800/60	
1800		1700	2300	001-001-1700/90°	001-002-1700/90°	001-003-1800/60	
Ø70		2000	1800	2500	001-001-1800/90°	001-002-1800/90°	001-003-2000/70
		2000	1900	2500	001-001-1900/90°	001-002-1900/90°	001-003-2000/70



D	E	F	G	H	I	J
						
050-001-400-650	050-005-400-650	050-003-400-650	050-004-400-650	050-009-M24	050-010-M24	050-011-M24
050-001-800-1000	050-005-800-1000	050-003-800-1000	050-004-800-1000	050-009-M30	050-010-M30	050-011-M30
050-001-1200-1800	050-005-1200-1800	050-003-1200-1800	050-004-1200-1800	050-009-M36	050-010-M36	050-011-M36
050-001-2000-2400	050-005-2000-2400	050-003-2000-2400	050-004-2000-2400	050-009-M42	050-010-M42	050-011-M42

UTR Prime Start 45°/90°



x	y	z	A	B
400	350	1000	011-001-350/45°	011-002-350/45°
500	450	1000	011-001-450/...	011-002-450/...
650	550	1200	011-001-550/...	011-002-550/...
650	600	1200	011-001-600/...	011-002-600/...
800	700	1300	011-001-700/...	011-002-700/...
800	750	1300	011-001-750/...	011-002-750/...
" - "	" - "	" - "	" - "	" - "
" - "	" - "	" - "	" - "	" - "
" - "	" - "	" - "	" - "	" - "
1800	1700	2300	011-001-1700/...	011-002-1700/...
2000	1800	2500	011-001-1800/...	011-002-1800/...
2000	1900	2500	011-001-1900/...	011-002-1900/...

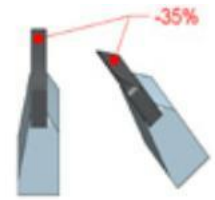

Start

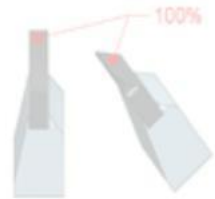

Standard

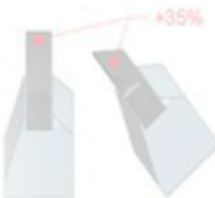

HD

UTR Prime HD 45°



x	y	z	A	B
400	350	1000	012-001-350/45°	012-002-350/45°
500	450	1000	012-001-450/45°	012-002-450/45°
650	550	1200	012-001-550/45°	012-002-550/45°
650	600	1200	012-001-600/45°	012-002-600/45°
800	700	1300	012-001-700/45°	012-002-700/45°
800	750	1300	012-001-750/45°	012-002-750/45°
" - "	" - "	" - "	" - "	" - "
" - "	" - "	" - "	" - "	" - "
" - "	" - "	" - "	" - "	" - "
1800	1700	2300	012-001-1700/45°	012-002-1700/45°
2000	1800	2500	012-001-1800/45°	012-002-1800/45°
2000	1900	2500	012-001-1900/45°	012-002-1900/45°

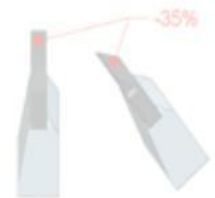

Start

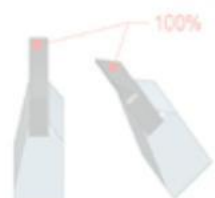

Standard

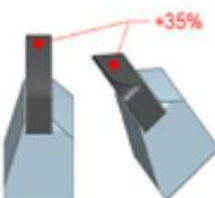

HD



X	S1	A	B1	B2	C
400 – 650 mm	M 24 x 160 mm	Ø 48 mm	58 mm	82 mm	150 – 200 mm
800 – 1000 mm	M 30 x 160 mm				200 – 300 mm
1200 – 1800 mm	M 36 x 200 mm	Ø 60 mm	65 mm	95 mm	~ 300 mm
2000 – 2600 mm	M 42 x 200 mm	Ø 70 mm			



X	S2	A	B1	B2	C	D
400 – 650 mm	SE-27	Ø 48 mm	58 mm	82 mm	100 – 200 mm	250 mm
800 – 1000 mm	SE-38				120 – 200 mm	290 mm
1200 – 1800 mm	SE-38	Ø 60 mm	65 mm	95 mm	150 – 250 mm	298 mm
2000 – 2400 mm	SE-45	Ø 70 mm				360 mm

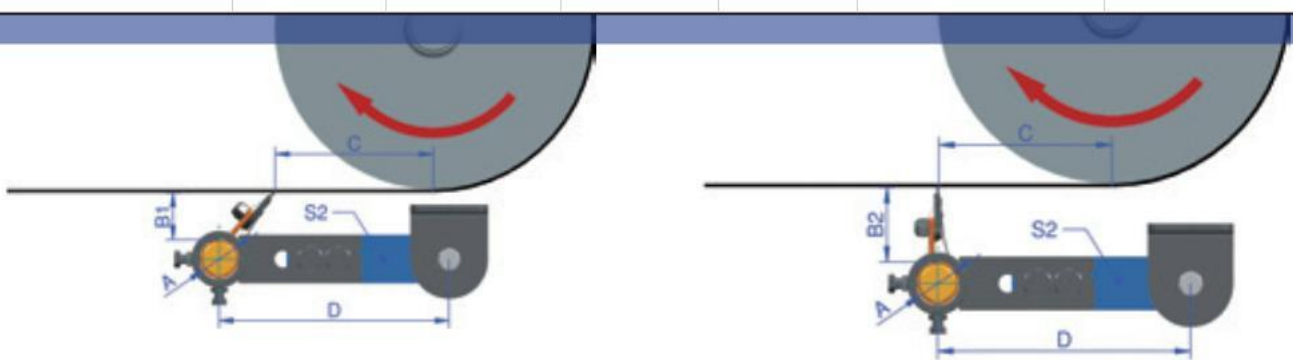

UTR Line

Air Gomm GmbH

V_{max}: 3.0 m/sec.



-100°C/+200°C

V_{max}: 3,5 m/sec.

-20°C/+70°C

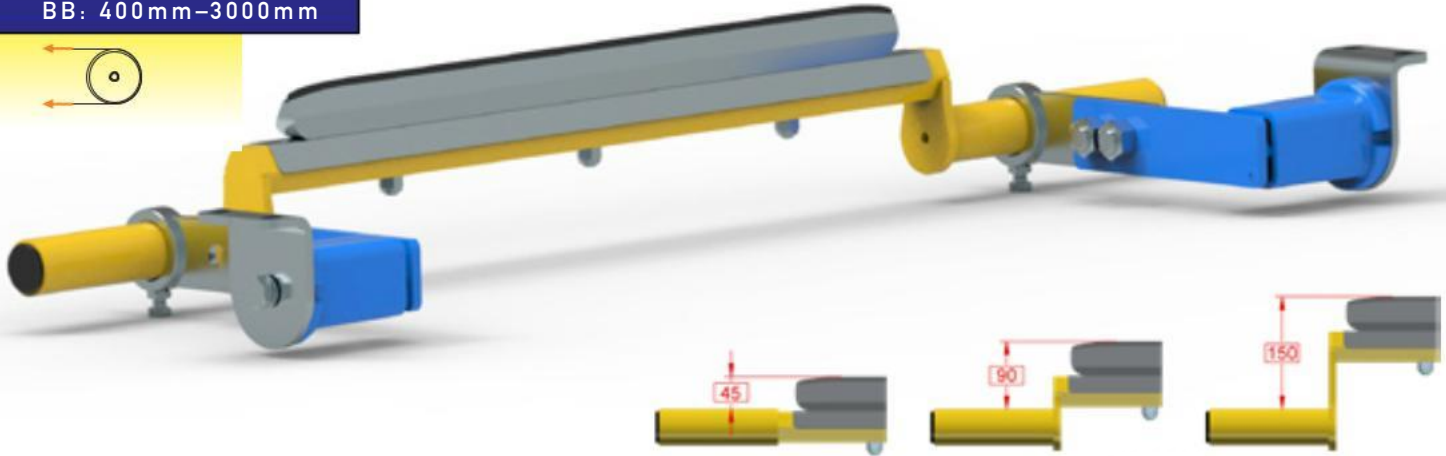
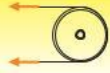
BB: 400mm-3000mm



x	y	z	 A			 B			 C																																																																										
			400	350	1000	003-001-350/45	003-002-350	003-003-400/45	400	350	1000	003-001-350/90	003-002-350	003-003-400/90	400	350	1000	003-001-350/150	003-002-350	003-003-400/150	500	450	1000	003-001-450/...	003-002-450	003-003-500/...	650	550	1200	003-001-550/...	003-002-550	003-003-650/...	650	600	1200	003-001-650/...	003-002-600	003-003-650/...	800	700	1300	003-001-700/...	003-002-700	003-003-800/...	800	750	1300	003-001-750/...	003-002-750	003-003-800/...	1000	900	1500	003-001-900/...	003-002-900	003-003-1000/...	1000	950	1500	003-001-950/...	003-002-950	003-003-1000/...	1200	1050	1700	003-001-1050/...	003-002-1050	003-003-1200/...	1200	1125	1700	003-001-1125/...	003-002-1125	003-003-1200/...	1400	1200	1900	003-001-1200/...	003-002-1200	003-003-1400/...	1400	1300	1900

Ø 48



D	E	F	G	H	I	J
						
050-001-400-650 050-001-800-1000	050-005-400-650 050-005-800-1000	050-003-400-650 050-003-800-1000	050-004-400-650 050-004-800-1000	050-009-M24 050-009-M30 050-009-M36/48	050-010-M24 050-010-M30 050-010-M36/48	050-011-M24 050-011-M30 050-011-M36/48

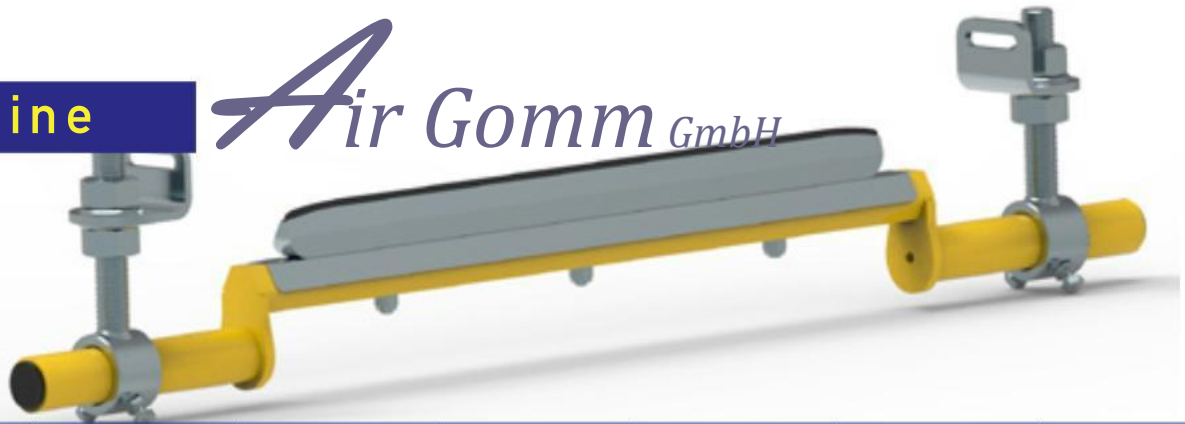

X	S1	A	B1	B2	B3	C
400 – 650 mm	M 24 x 160 mm	Ø 48 mm	45 mm	90 mm	150 mm	150 – 200 mm
800 – 1000 mm	M 30 x 160 mm					200 – 300 mm
1200 – 1400 mm	M 36 x 160 mm					– 300 mm



X	S1	A	B1	B2	B3	C	D
400 – 650 mm	SE-27	Ø 48 mm	45 mm	90 mm	150 mm	100 – 200 mm	250 mm
800 – 1000 mm	SE-38					120 – 200 mm	290 mm
1200 – 1400 mm						150 – 250 mm	

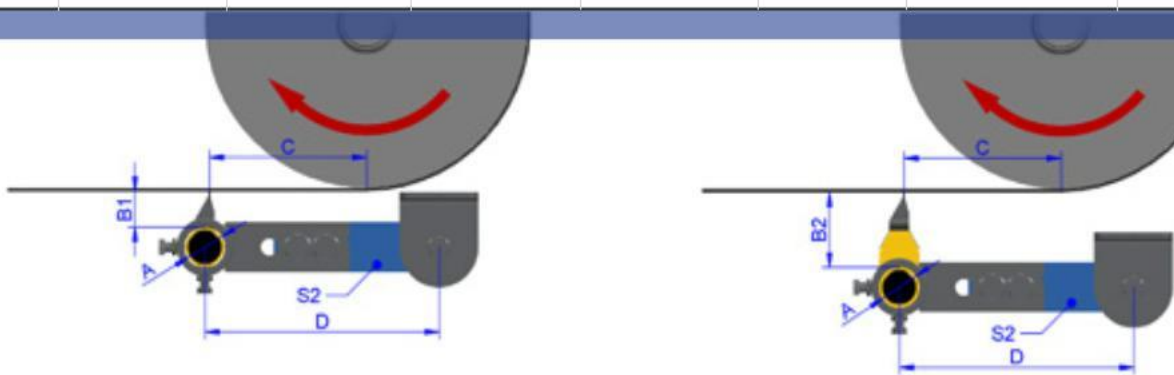

UTR FLIP

Vmax: 2,5 m/sec.

-30°C/+60°C

BB: 400mm-1400mm

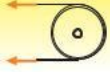

Air Gomm GmbH



	Dimensions			Parts				
	x	y	z	A	B	C		
30x30	400	350	1000	008-001-350	050-002-400-800	050-016-400-800		
	500	450	1000	008-001-450				
	650	550	1200	008-001-550				
	650	600	1200	008-001-600				
	800	700	1300	008-001-700				
	800	800	1300	008-001-800				
	1000	900	1500	008-001-900			050-002-1000-1400	050-016-1000-1400
	1000	1000	1500	008-001-1000				
1200	1100	1600	008-001-1100					
1200	1200	1600	008-001-1200					
1400	1300	1600	008-001-1300					



X	S2	A	B	C	D
400 – 800 mm	SE-27	□ 30mm	75 mm	50mm - 100mm	230 mm
1000 – 1400 mm	SE-38				280 mm

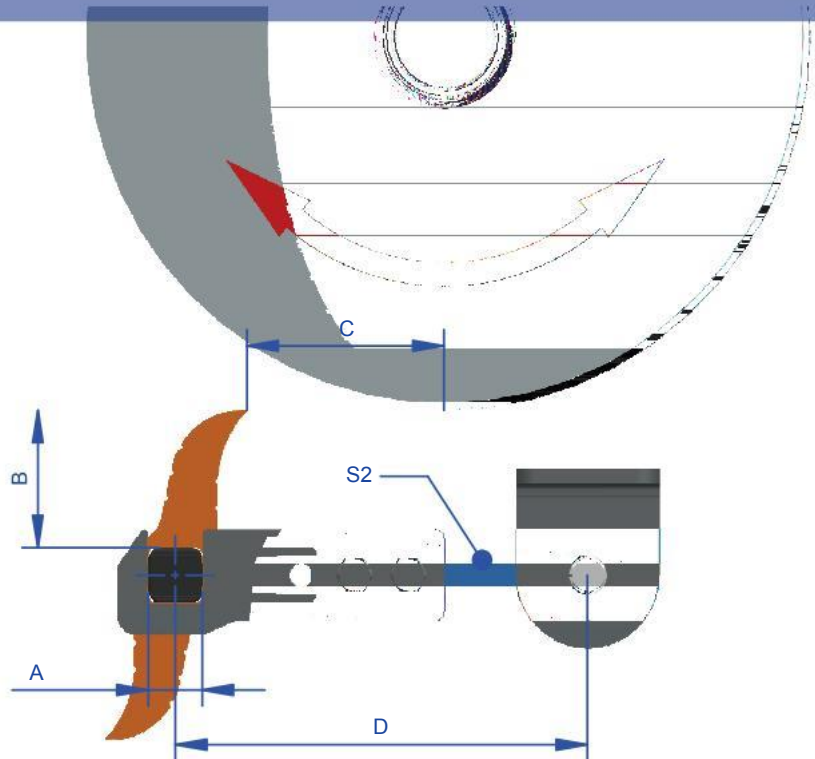

UTR Neo S

Air Gomm GmbH

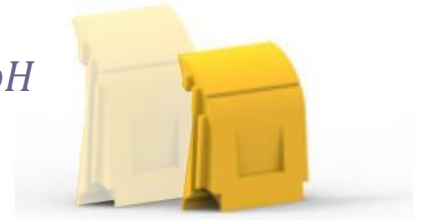



Neo M Neo S

Vmax: 3.5 m/sec.

-30°C/+80°C

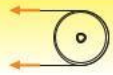
BB: 400mm-2000mm



	x	y	z	A	B
Ø 48	400	300	1000	006-001-300	
	500	300	1000	006-001-300	
	650	450	1200	006-001-450	
	800	600	1300	006-001-600	
	1000	750	1500	006-001-750	
Ø 60	1200	900	1700	006-001-900	
	1400	1050	1900	006-001-1050	
	1600	1200	2100	006-001-1200	
	1600	1350	2100	006-001-1350	
	1800	1500	2300	006-001-1500	
	1800	1650	2300	006-001-1650	

	X	S
	BB 400 – 1000 (Ø 48)	050-020-48
	BB 1200 – 1400 (Ø 60)	050-020-60
	BB 1600 – 1800 (Ø 60)	050-021-60

UTR Neo M

Air Gomm GmbH

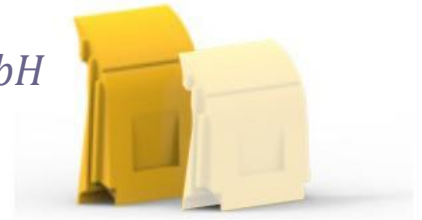

Neo M Neo S

Vmax: 3,5 m/sec.

-30°C/+80°C

BB: 400mm-2000mm

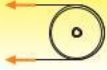

x	y	z	A		B	
			Code	Code		
400	300	1000	005-001-300	005-002-150		
500	400	1000	005-001-300			
650	450	1200	005-001-450			
800	600	1300	005-001-600			
1000	750	1500	005-001-750			
1200	900	1700	005-001-900			
1400	1050	1900	005-001-1050			
1600	1200	2100	005-001-1200			
1600	1350	2100	005-001-1350			
1800	1500	2300	005-001-1500			
1800	1650	2300	005-001-1650			

S	X		S
	BB	Code	
	400 – 1000 (ø 48)	050-020-48	
	1200 – 1400 (ø 60)	050-020-60	
	1600 – 1800 (ø 60)	050-021-60	

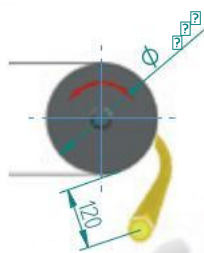

Neo S

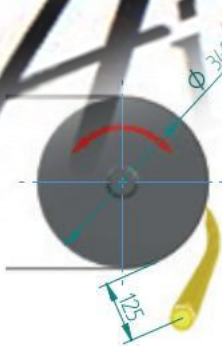
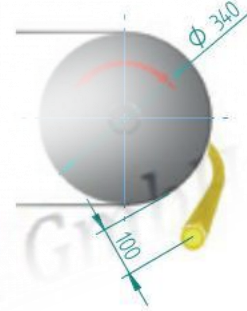
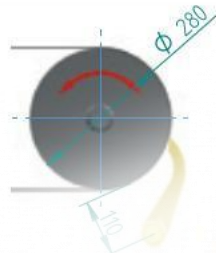

Neo M

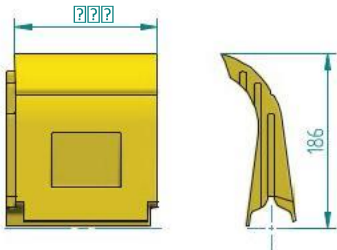
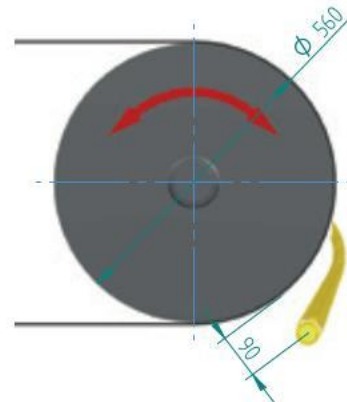
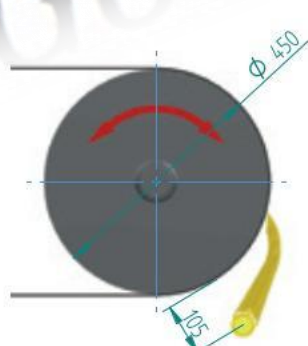

Neo S

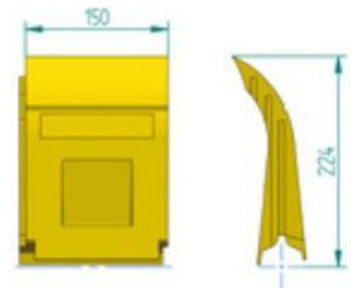
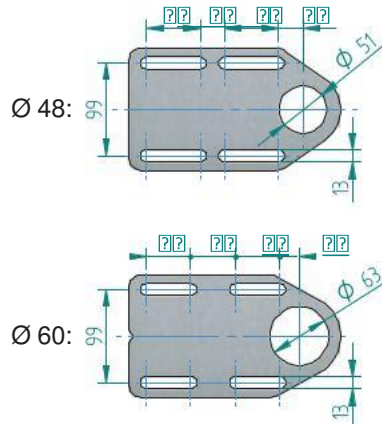

Neo M

UTR X-Clean

Air Gomm GmbH

Vmax: 3m/sec.

-30°C/+80°C

BB: 400mm-2000mm

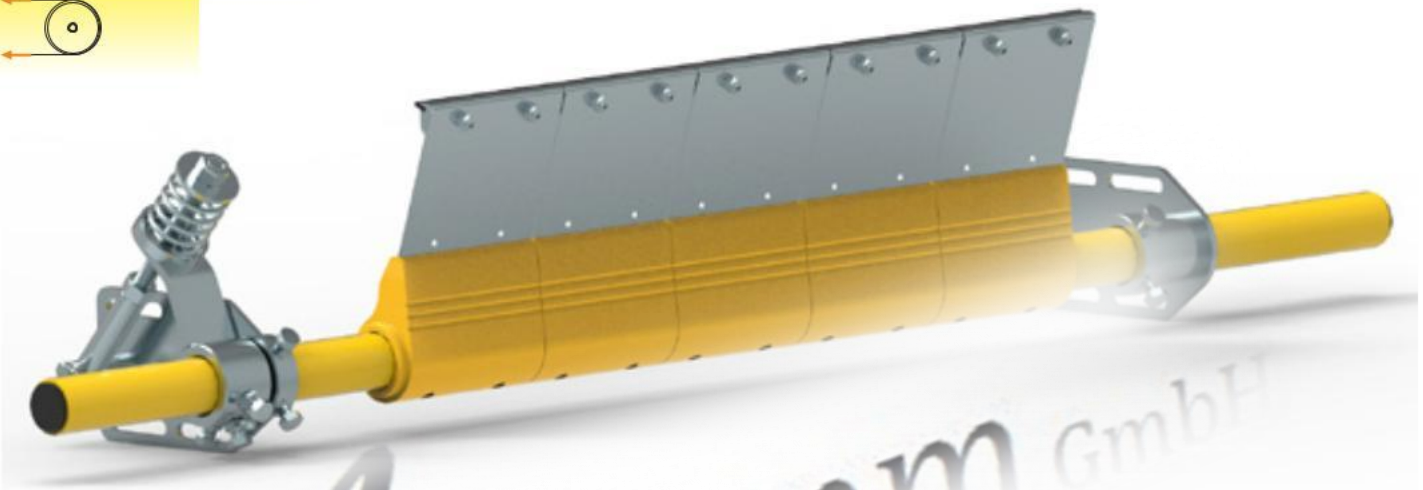
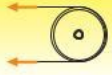

x	y	z	A	B	C
400	300	1000	004-001-300		
500	300	1000	004-001-300		
650	450	1200	004-001-450		
800	600	1300	004-001-600		
1000	750	1500	004-001-750		
1200	900	1700	004-001-900		
1400	1050	1900	004-001-1050		
1600	1200	2100	004-001-1200		
1600	1350	2100	004-001-1350		
1800	1500	2300	004-001-1500		
1800	1650	2300	004-001-1650		

	x	S
	BB 400 – 1800 (Ø 48)	050-020-48

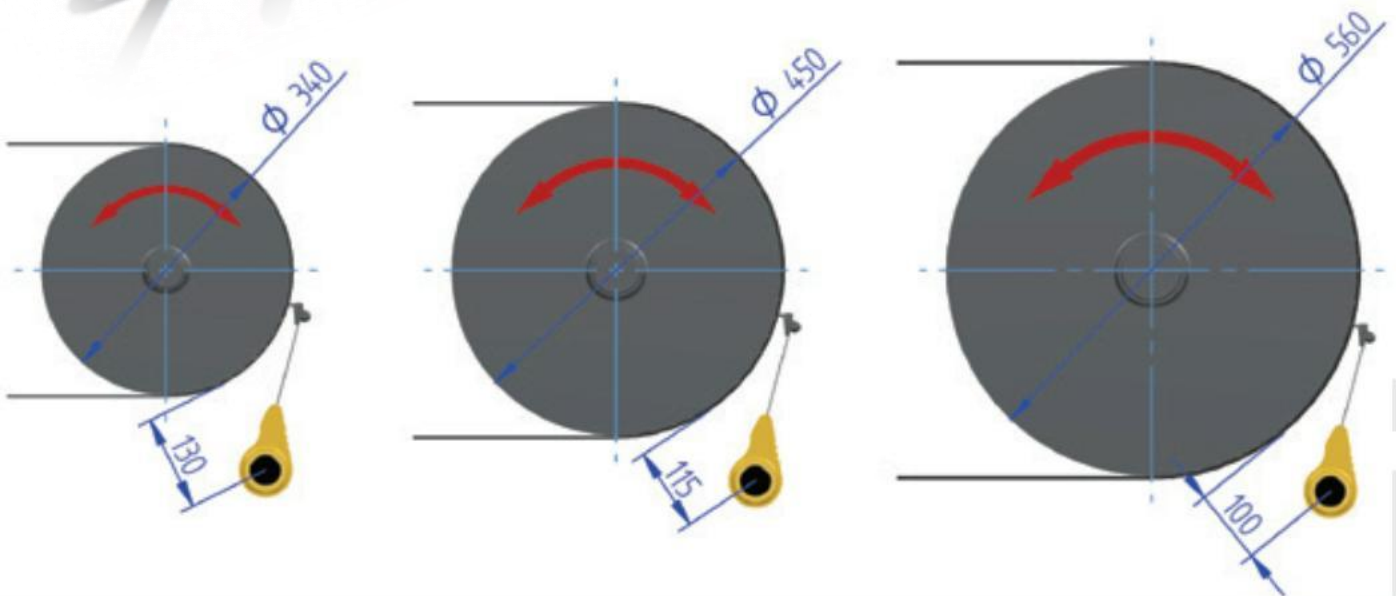
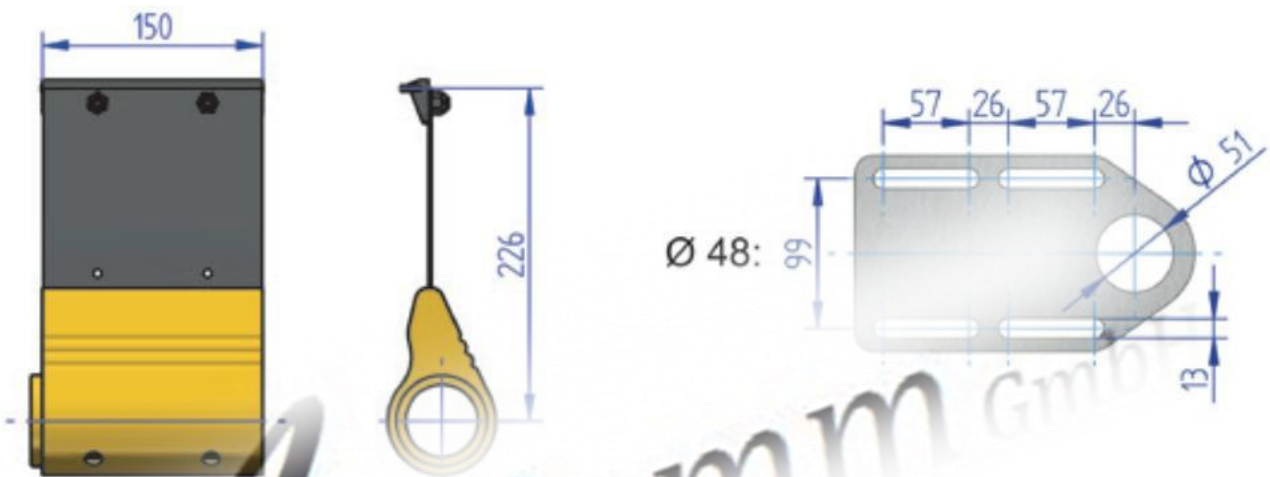
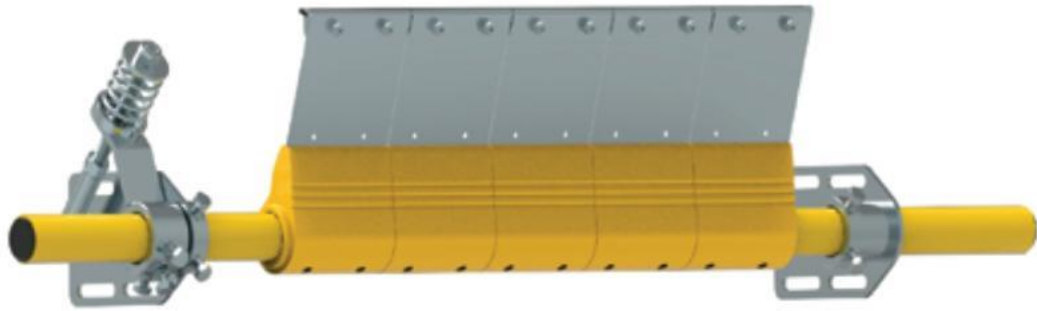

UTR Wing

Air Gomm GmbH

Vmax: 3m/sec.

-30°C/+80°C

BB: 400mm-1600mm

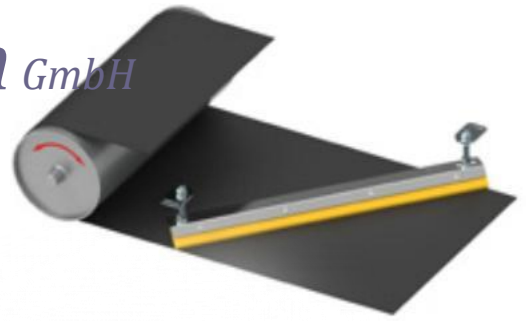

Air Gomm GmbH



x	y	A	B
400	450	002-001-400	002-002-400
500	550	002-001-500	002-002-500
650	700	002-001-650	002-002-650
800	850	002-001-800	002-002-800
1000	1050	002-001-1000	002-002-1000
1200	1250	002-001-1200	002-002-1200
1400	1450	002-001-1400	002-002-1400
1600	1650	002-001-1600	002-002-1600

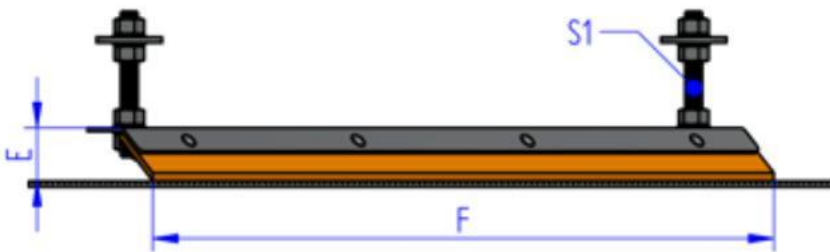
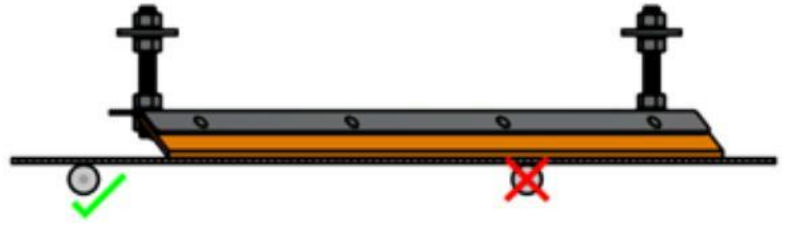

X	S1	E	F
400 mm			590 mm
500 mm			710 mm
650 mm			895 mm
800 mm	M24 x 200 mm	75 mm	1080 mm
1000 mm			1320 mm
1200 mm			1565 mm
1400 mm			1810 mm

UTR Double Wing



Air Gomm GmbH

Vmax: 3m/sec.

-30°C/+80°C

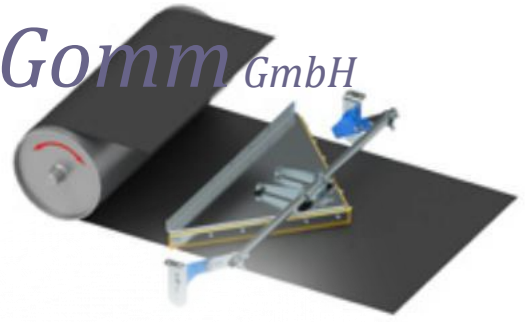
BB: 400mm-1600mm



					
	x	y	z	A	B
Ø 38	400	450	1000	007-001-400	007-002-400
	500	550	1000	007-001-500	007-002-500
	650	700	1200	007-001-650	007-002-650
	800	850	1300	007-001-800	007-002-800
	1000	1050	1500	007-001-1000	007-002-1000
	1200	1250	1700	007-001-1200	007-002-1200
	1400	1450	1900	007-001-1400	007-002-1400
	1600	1650	2100	007-001-1600	007-002-1600

UTR Double Wing

Air Gomm GmbH

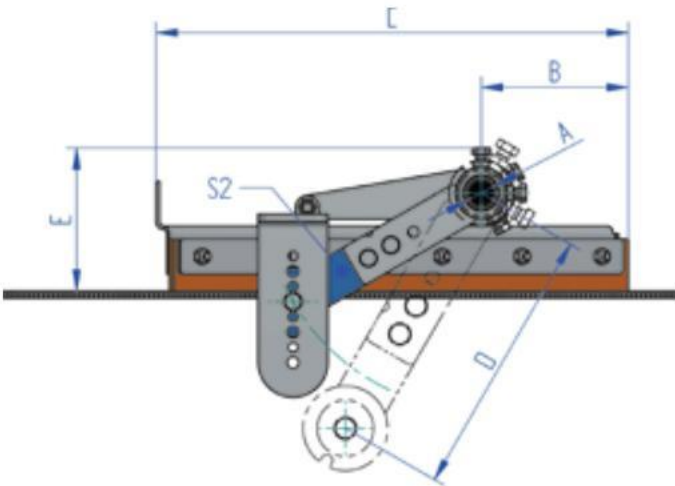
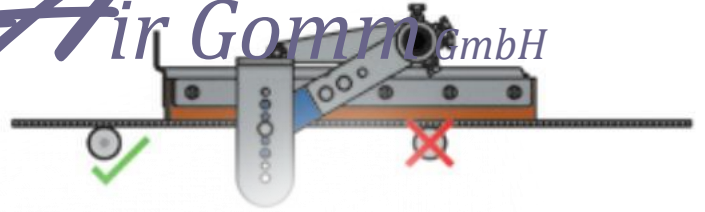

X	S2	A	B	C	D	E	Z
500 mm				295 mm			800 mm
650 mm				370 mm			1000 mm
800 mm				445 mm			1100 mm
1000 mm	SE-27	Ø38	170mm	545 mm	250 mm	165 mm	1300 mm
1200 mm				645 mm			1500 mm
1400 mm				745 mm			1700 mm



Ihr Servicepartner

Air Gomm GmbH

Bahnhofstrasse 5
CH-5316 Felsenau / AG,
+41 56 246 12 13,
info@air-gomm.ch

SIMPLE & CLEAN

UR
www.air-gomm.ch